



UNDERFLOOR HEATING MATS

Installation Instructions

Under Tile Mat System - 200 watts/m²

Product Type: TRM200

The ThermRite under tile sticky mat heating system is suitable for a wide range of floor coverings – ceramic, stone, limestone, slate, terracotta, porcelain or marble. The system is designed for installation directly below tiles and stone flooring, and the following instructions should be read carefully before you begin your installation.

Please read these instructions and complete your Guarantee and return it to the Distributor / Supplier after installation. It is important to carry out and record the electrical tests as required by law to conform with the current IEE Electrical Regulations and Part P of the Building Regulations.

ThermRite Mat systems can be applied to insulation construction boards, concrete, and existing old tile surfaces. Insulation construction board is already primed, comprising a cement polymer mortar finish on both sides of the board.

Electrical Requirements

It is recommended the installation is carried out in accordance with local electrical regulations and the wiring of the system to the mains electrical supply is performed by a qualified electrician. **Wiring and circuit protection must conform to the latest IEE Electrical Regulations.**

The heating system is designed for operation at 230V 50Hz.

Installations require a 30mA RCD (residual current device) for safe operation and a dedicated RCD must always be installed if not already existing.

It is possible to run the heating from an existing circuit – **always consult your electrician to check if the circuit can handle the load (amperage) and the circuit is RCD protected.** Make sure the total current (amps) of your ThermRite Mat system and other appliances connected to the circuit do not exceed the current capacity of the circuit.

Normal ring main circuits are rated at 13A and the electrical feed can be taken from a 30mA RCD via a 13A fused spur.

Before commencing check the total load your chosen thermostat is designed to switch. For high loads you may need to install an electrical contactor. When using a 16A thermostat for example, the total load of your ThermRite system must not exceed 3600 watts (24m² system for 150watts/m² mats). For larger areas a contactor must be used to switch the electrical load. Alternatively, split the heating into more than one heating zone, each operated by its own thermostat – **always consult your electrician.**

In bathrooms the thermostat control should be mounted outside the bathroom as close to the underfloor heating as possible.

The underfloor heating must be controlled via a floor sensor thermostat at all times.

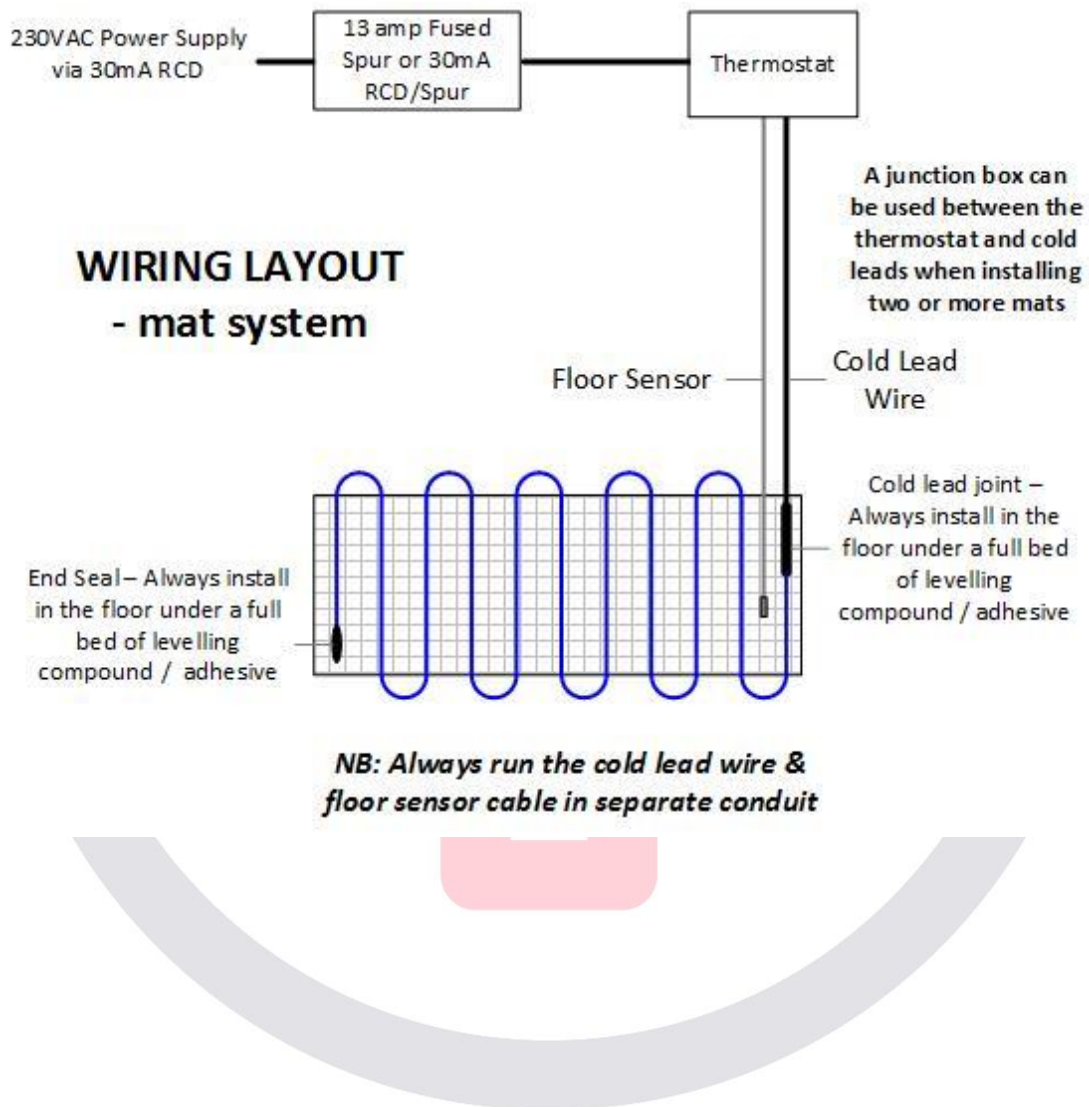

Part Number	Heated Floor Area (m ²)	Heating Mat(s) Required	Total Watts	Amps
TRM200-200	1	1 x 1.0m ²	200	0.9
TRM200-300	1.5	1 x 1.5m ²	300	1.3
TRM200-400	2	1 x 2.0m ²	400	1.74
TRM200-500	2.5	1 x 2.5m ²	500	2.2
TRM200-600	3	1 x 3.0m ²	600	2.6
TRM200-800	4	1 x 4.0m ²	800	3.47
TRM200-1000	5	1 x 5.0m ²	1000	4.34
TRM200-1200	6	1 x 6.0m ²	1200	5.22
TRM200-1400	7	1 x 7.0m ²	1400	6.08
TRM200-1600	8	1 x 8.0m ²	1600	6.96
TRM200-1800	9	1 x 9.0m ²	1800	7.83
TRM200-2000	10	1 x 10.0m ²	2000	8.7
TRM200-2200	11	1 x 1m ² , 1 x 10.0m ²	2200	9.6
TRM200-2400	12	1 x 2m ² , 1 x 10.0m ²	2400	10.43
TRM200-2600	13	1 x 3m ² , 1 x 10.0m ²	2600	11.33
TRM200-2800	14	1 x 4m ² , 1 x 10.0m ²	2800	12.17
TRM200-3000	15	1 x 5m ² , 1 x 10.0m ²	3000	13.03
TRM200-3200	16	1 x 6m ² , 1 x 10.0m ²	3200	13.9
TRM200-3400	17	1 x 7m ² , 1 x 10.0m ²	3400	14.77
TRM200-3600	18	1 x 8m ² , 1 x 10.0m ²	3600	15.65

The heating cable must never be cut.

To facilitate installation the cold lead wire can be cut shorter to suit.

FLOOR PREPARATION

Wooden Subfloors – timber floorboards and chipboard. Make sure any loose boards are firmly fixed and reinforce the floor if necessary. This will prevent any movement in the floor that could cause tiles to crack. **The floor must be level.**

A rigid base floor is essential. Fixing reinforcements direct to joists will not provide a suitable floor finish for tiles. Reinforcement can be applied to the rigid base floor by covering the complete floor with 18mm WBP plywood (weather & boil proof plywood), or alternatively 10mm thick insulated tile backer board (construction board).

Reinforcements to be applied in accordance with the manufacturer's instructions.

Concrete Subfloors – Before proceeding repair any imperfections in the floor and level the floor with approved building materials.

When practical, use XPS or tile backer insulation boards if installing the mat directly onto a concrete floor.

Wooden & Concrete Subfloors - Clean the floor surface so that it is free from dust, dirt, grease etc.

When it is practical, tile backer insulation construction board can be applied overall to both wooden and concrete sub floors.

Prime subfloors with a suitable primer to improve bonding between tile adhesives and the subfloor. A primer with a flexible admix is recommended. This is used to prepare and stabilise porous and dusting surfaces prior to tiling and to improve adhesion on difficult substrates, such as timber, concrete and terrazzo.

When installing insulation construction boards use tile adhesive to fix the boards to concrete floors and galvanised screws/washers on wooden subfloors.

NOTE: Insulation construction board is already primed, comprising a cement polymer mortar finish on both sides of the board.

FIRST STEP

Plan the installation.

Draw a general view of the room and mark the area which will be covered with heating elements. Avoid heating under units and sanitary ware as this can cause heat blockage and it is unnecessary to heat these areas anyway.

Mark the position of the supply lead(s) – the cold lead wire(s), at floor level. In most cases this will be close to and below the thermostat position.

When decided on this position you can cut a groove in the floor to accommodate the protective floor sensor tube. The sensor must run centrally (in the middle) between two runs of heating element so it is important to note where the elements will be positioned. Make the sensor tube level with the heating element as shown below.

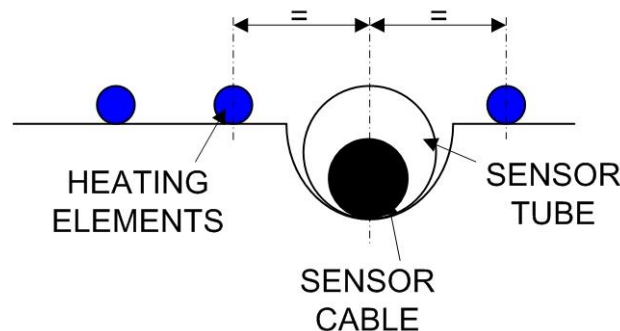

The black cable joint between heating element (blue cable) and cold lead wire (black cable) must be located on the floor. This joint should be level with the heating system – another small groove in the floor may be necessary.

Do not tape over manufactured cable joints, cable end seals and the thermostat floor sensor. Taping over the tip of the sensor when securing the sensor in place may result in inaccurate temperature readings. When possible, always use the sensor tube when installing the thermostat sensor cable. Seal the end of the tubing (conduit) with tape to prevent adhesive or screed from entering the conduit.

Make sure the sensor tube has a gradual bend when it enters the floor coming down from the wall, this will ensure the sensor cable can be easily inserted or withdrawn.

Floor Insulation

On wood or concrete subfloors, a thermal barrier between the heating element and subfloor will increase performance and heat up time. This will add the benefit of improving the insulation properties, and only a 10mm maximum thickness is required to obtain good results and the necessary thermal barrier.

To maximise the efficiency of the installed heat energy it is also good practice to have insulation installed below the sub-floor, but on renovation projects this is sometimes not practical due to the age of the property.

Testing

IMPORTANT: Before and during installation electrical tests are necessary. We recommend the use of a digital multi-meter set to a range of 0-2K ohms for testing.

- Test before installing, immediately after installing and after tiling. **Consult a qualified electrician.**

The digital multimeter is ideal for testing cable continuity and its resistance (ohms), as well as the resistance of the sensor cable. Check the sensor cable resistance with the digital multimeter. The reading should be between 9 – 23 ohms depending on room temperature.

All test results to be recorded on the Guarantee sheet.

- Live to neutral will show the ohms values listed in the product table.
+/- 5% ohm reading is allowed under manufacturing guidelines.
- Live to earth and neutral to earth should show infinity.

Insulation resistance readings should also be carried out as required by IEE Regulations.

Due to the high resistance of the heating element, continuity testers are not recommended. When checking resistance, make sure your hands do not touch the meter's probes as the measurement will include your body resistance making the measurement inaccurate.

Mat Layout & Fixing

Planning is important and when calculating the heated floor area, plan to leave a gap unheated around the room perimeter of approx. 50 - 100mm. The heated floor area must be free, avoid heating under kitchen cabinets, sanitary ware and appliances. To estimate the mat size a good guide is to measure the total floor area of the room, take away 10%, then take away the area of any fixed objects.

Make sure the ThermRite system can fit the floor area to be heated. It is better to have just too little than too much over. Remember, **NEVER** cut the heating element. Cut only the element carrier when needed and turn / flip the mat to meet your requirements as shown in the small illustrations below.

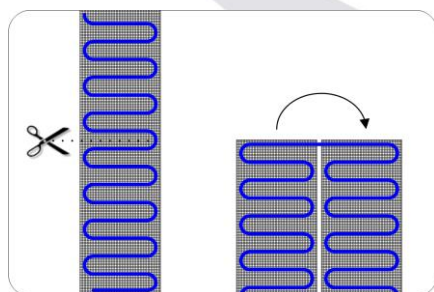

PLAIN WALL CUT

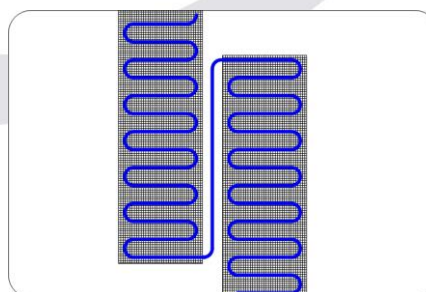

LOOSE CABLE

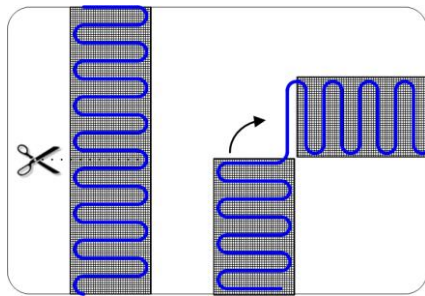

OPEN CORNER

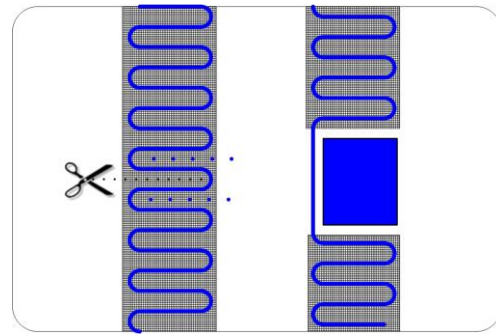

OBSTACLE CUT

The position for the thermostat should have been decided at the initial planning stage.

Use a marker pen to draw out the areas on the floor where units and fixtures will be placed.

Start by laying the mat in the closest location to the thermostat position.

Check that the cold lead wire for the mat(s) will reach the connection – (this is the connection with the junction box depending on the number of mats, or direct to the thermostat). If it does not, extend by removing some of the heating element from the carrier and fix the loose heating element to the floor with duct tape.

Arrange the mat on the floor, roll out and make the appropriate cuts at walls, starting at the closest location to the thermostat position. To facilitate installation of heating cable into recesses, open corners and obstacle cuts, loose cable can be removed from the fibreglass mesh. DO NOT allow the heating element to cross or touch, and make sure the loose wire is no closer than 50mm from each other, walls and other wires still attached to the mesh.

Loose wire taken from the mat can be secured to the floor using duct tape.

NEVER CUT THE HEATING ELEMENT

Do not remove the two-sided adhesive tape until you have planned which way you intend to lay the mat.

Fix the mat to the floor using its self-adhesive mesh. In addition, the double-sided tape can be used. Once the mat is in position press over the mat lightly to ensure good adhesion.

Use duct tape to fix any loose cables removed from the mat.

Typical Layout of the ThermRite Under Tile Sticky Heating Mat System

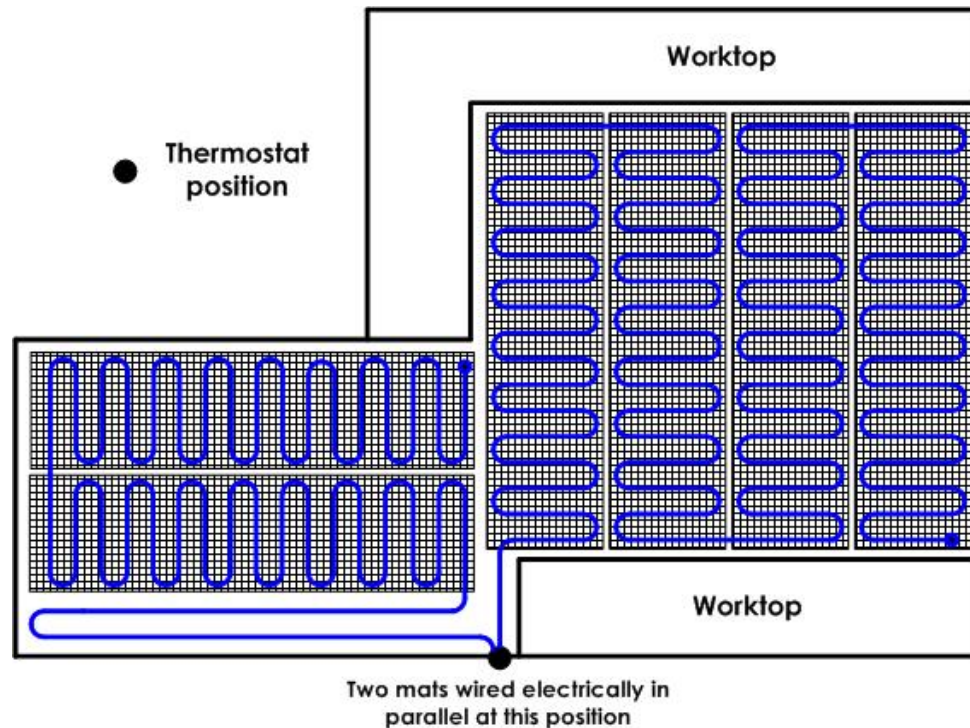

Tiling

To fix tiles select a single step or two step method. Latex, acrylic or polymer-based adhesives are acceptable.

Single Step: Using a flexible adhesive the tiling can be carried out as a single operation directly on top of the heating mat. Allow a depth of adhesive sufficient to lay the tile and to encapsulate the heating element with no air gaps

Two Steps: Apply a thin layer of flexible self levelling compound just sufficient to cover the mat and encapsulate the heating elements with no air gaps. Allow to cure in accordance with the manufacturer's instructions. This will provide protection to the heating mat and a flat surface, prior to tiling. Next apply the tiles in flexible tile adhesive in the normal manner.

Both steps are approved for under tile heating.

All adhesives must be flexible and suitable for underfloor heating.

Grouting

Use a **latex, acrylic or epoxy grout** for grouting between the tiles. Latex, acrylic and polymers add flexibility to grouts to resist cracking. Epoxy grouts provide high strength, good thermal shock resistance and fast cure. Do not use sharp objects to clean the grout from between the tiles. Damage to heating cables can occur when excess grout is scraped away and a sharp tool goes deep enough to cut the cable.



Reminders

Do – Read the instructions before commencing installation and consult a qualified electrician.
Do - Use approved adhesives and floor screeds – consult your local tile or builders merchant
Do - Test the heating before, during and after installation and record the results in the Guarantee Certificate. Always check the mat is working before commencing tiling.
Do - consult a qualified electrician and ensure the installation is carried out to comply with the latest IEE Wiring Regulations and Part P of the Building Regulations
Do - Plan your mat layout and installation
Do – Install the thermostat floor sensor centrally between two runs of heating cable
Do – make sure to record the mat layout
Do – ensure the floor is smooth, clean and dry before priming with a suitable floor primer
Do - Ensure that a heat loss calculation has been carried out to meet the heating requirements if the system is being used as a primary source of heat.
Do - Maintain a minimum gap between loose wire runs of 50mm (2")
Do - make sure the heating is connected to an RCD rated 30mA maximum.
Do - make sure both the cable end cap and the black joint between the blue heating element and the black cold lead wire is in the floor beneath tiles and fully encapsulated in tile adhesive or levelling compound.
Do - keep a record of where the floor probe is positioned. Also, record the general layout of the heating mat for future reference and to avoid any damage to the heating cable caused by drilling after tiling

Don't - overload circuits – consult your Electrician
Don't - cut or shorten the heating element
Don't - cross or touch heating elements
Don't - cut or prepare tiles on top of the mat
Don't - tape over the end joint or manufactured joint
Don't - Use the heating system to dry out the tile adhesive or levelling compound
Don't - Bend the heating cable under 25mm radius
Don't - Start tiling before testing the mat
Don't - Switch on the installed mat until 8 days after fitting to allow the tile adhesive to dry.
Don't - Connect two mats in series, only connect mats in parallel
Don't - Leave surplus matting rolled up under units or fixtures – always use the right size
Don't - Run the floor sensor or power lead over or under the heating element or close to other heat sources such as hot water pipes
Don't - Commence installation on a concrete floor that has not been fully cured
Don't - Use staples to fix the heating element to the floor
Don't - Use sharp tools or objects to clean excess group from between tiles



WARRANTY CERTIFICATE

ThermRite Under Tile Mat Heating System – TRM200

Please complete and return this warranty certificate to your distributor / supplier within 30 days of purchase and keep a copy

Name:

Address:

..... Phone No.:

Type of room:

Part Number(s)

.....

Purchased from: Date of Purchase:

Customers Invoice Number:

Initial Resistance test (continuity) (ohms)

Insulation Resistance:

Signed by electrician / installer:

Date:

Resistance test (continuity) prior to laying tiles(ohms)

Insulation Resistance – prior to laying tiles

Signed by electrician / installer:

Date:

Final Resistance test (continuity)(ohms)

Insulation Resistance:

Signed by electrician / installer:

Date of completion:

